

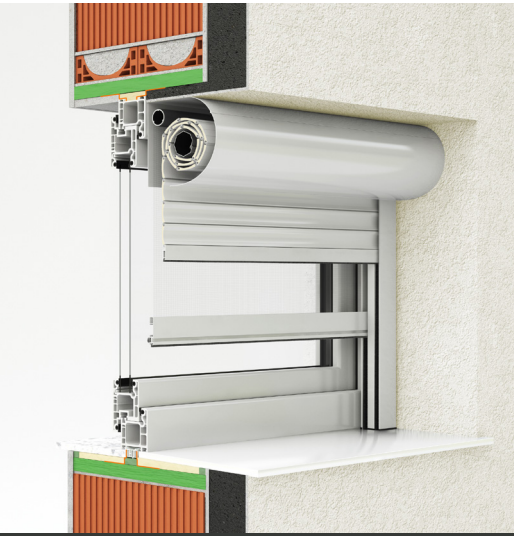

External roller shutter OVAL



- HEAT PROTECTION
- ANTI-THEFT PROTECTION
- LIGHT REGULATION
- DIMMING
- UV PROTECTION
- HEATING / COOLING SAVINGS

One of the most sophisticated mount-on visible shutters is definitely the OVAL shutter because its shape additionally contributes to a better exterior appearance. The oval box forms a completed whole with the shutters and the facade. The oval box is composed of three parts: rear, top, and front service panel, all of which are made of extruded aluminium, which adds the extra stiffness and a better appearance to the box.

SLATS | Color palette:

WARNING: Certain colours on the chart may vary from original!

	PC1	01 WHITE	02 D. CHOCO	03 SILVER	05 L. CHOCO	04 BEIGE	08 GREEN	10 L. GREY	11 ANTIKO GRISO	13 GRAPHITE	06 ASH	07 WALNUT	16 GOLDEN OAK
		12 ANTHRACITE	14 RAL 9007	52 EB 703		15 OCHRE	18 RAL 8017	24 RAL 9005			17 WALNUT SEA		
	PC1	01 WHITE	02 D. CHOCO	03 SILVER	04 BEIGE								
		11 ANTIKO GRISO	12 ANTHRACITE	14 GREY	52 EB 703								
	PC1	01 WHITE	03 SILVER										
		12 ANTHRACITE	52 EB 703										

* colors 02, 04, 11, 14 available for orders over 50m²

ALU slats are filled with insulation - polyurethane foam, standard fitted with anti-theft springs. Machine slat binding ensures a quieter and more reliable operation.

CABINET, GUIDERAILS, END SLAT | Color palette:

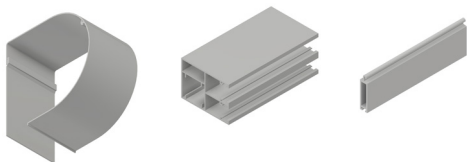

PC1	013 WHITE	010 RAL 9006	090 RAL 9007	
	042 RAL 7005	066 RAL 8012	052 EB 703	

WARNING: Certain colours on the chart may vary from original!



MANIPULATION:



Manipulation is possible with automaton or electrical motor. For motor operation there is the standard PLUG & PLAY function, which allows the connection of several motors to a single switch, self-adjusting positions and the safety function in the event of an obstacle.



External roller shutter OVAL

TEHNICAL DRAWINGS | Shade details:

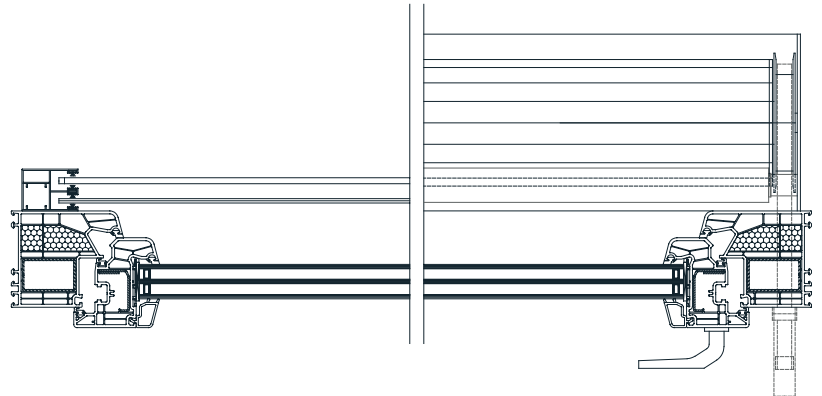
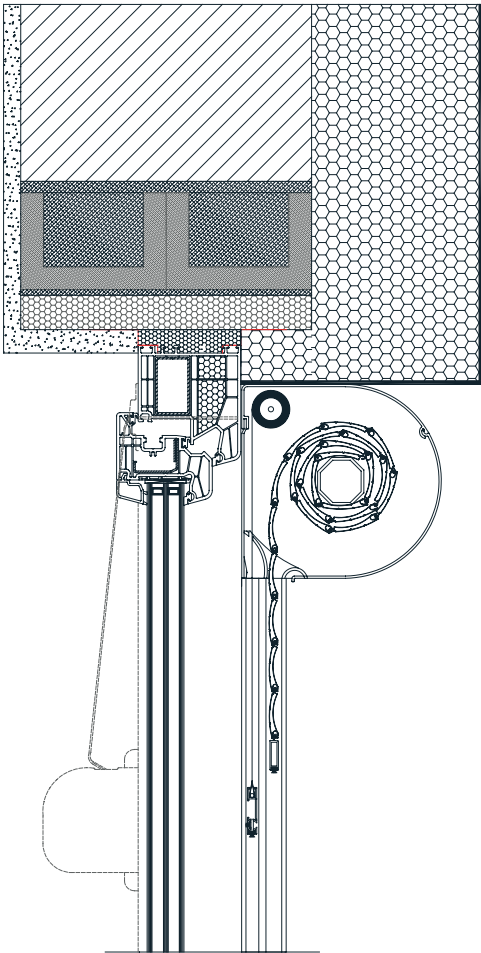

OVAL 137

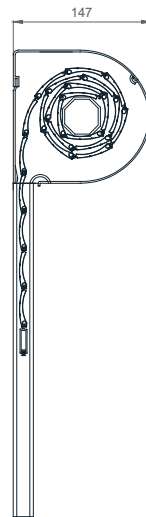

OVAL 165

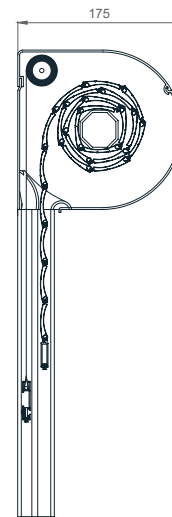

OVAL 180

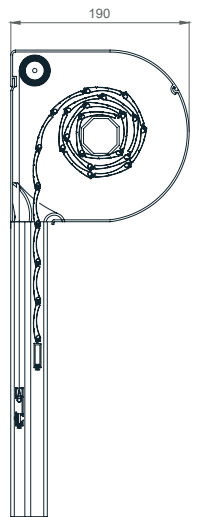

GUIDERAILS

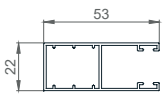

53 X 22mm

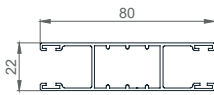

80 X 22mm

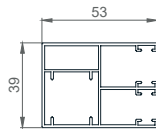

53 X 39mm

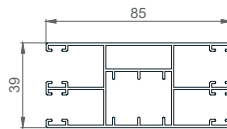

85 X 39mm

SLATS

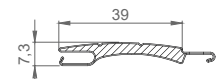

FALCON - 39mm

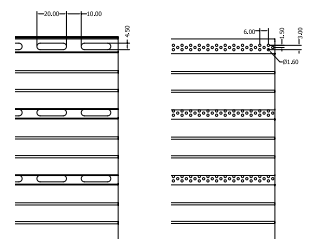

PERFO

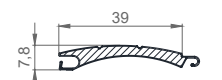

ALU - 39mm

TABLE OF BOX (CABINET) SIZES

Slat/Shaft cabinet size	FALCON / 60mm		ALU / 40mm		ALU / 60mm	
		MOS.		MOS.		MOS.
13,7 cm	110,0	-	173,9	-	146,3	-
15,0 cm	-	-	-	-	-	-
16,5 cm	184,0	141,0	265,0	202,3	249,9	189,9
18,0 cm	249,0	210,0	319,9	255*	309,9	255*
20,5 cm	-	-	-	-	-	-